

CARTRIDGE TYPE ADHESIVE COMPOUNDS



Z Bond Ezy Caulk	White	500g	007161
Oil Based Secomastic		300g	007167
Non-Acetic Silicone VEC5CLM	Grey	370g	007168
Non-Acetic Silicone VEC5CLM	White	370g	007169
Silicone Z Bond V2	White	300g	007171
Silicone Z Bond V2	Clear	300g	007172
Silicone Z Bond V4	White	370g	007173
Silicone Rhodorsil V60 Clear		300g	007174
Silicone Rhodorsil V60 White		300g	007175
Z Bond Roof & Gutter	Clear	300g	007180
Z Bond No Nails Adhesive		320g	007200

STOP LEAK CARAVAN SEALER



Flexible waterproof membrane for caravan joins and seams. Brush on.

White		
1 litre		035432
4 litre		035434
Cream		
1 litre		035433
4 litre		035442

ROOF PROOF



Latex based waterproofing paint for application to roof joins, edge trims and around the perimeter of all roof fittings.

White		
1 litre		007182
4 litre		007183
Cream		
1 litre		007184
4 litre		007185

POLYSTYRENE ADHESIVE



A specially formulated red adhesive for bonding polystyrene plywood and aluminium. 4 litre. **007201**

DAMP RID DEHUMIDIFIER



Protects against damp, mildew and rust.

340g	Starter Pack	035473
1.36kg	Refill	035470

DURALAC JOINING COMPOUND



Inhibits electrolysis corrosion between dissimilar materials. 115ml **033257**

FIAMMA HELPING HAND DOOR HANDLE



Handle folds flush to door for safety and added security. Assists when entering and leaving the van. Suits both right hand and left hand doors. Fitted with key lock and safety release handle.

460mm (h)	000747
310mm (h)	000746

BARREL BOLTS



Brass chrome plated	
34mm	007989
50mm	007990

CABIN HOOKS



75mm	008182
100mm	008183
150mm	008185
200mm	008186
Eye only	008187

CABIN HOOK RETAINER



Plastic retainer to secure cabin hooks while travelling **015638**

PLASTIC KNOBLOCK WITH METAL PLATE



Push out window swivel lock. Plastic lever with metal base

Black **008553**
White **035438**

KNOBLOCK - ALL PLASTIC



Grey nylon push out window lock. **008556**

MILLARD CUPBOARD CATCH



Brown 2 piece **008081**

FRANKLIN CUPBOARD CATCH



Brown 2 piece **008078**

MILLARD PULL CUPBOARD CATCHES - NO KNOB



2 piece short stem. Suits 10mm door thickness. Accepts various knobs. **008079**



2 piece long stem. Suits 20mm door thickness. Accepts various knobs. **008080**

CUPBOARD CATCH PUSH BUTTON TYPE



Can be used with any handle.

Gold **008072**
Chrome **008073**

PUSH ROD



White **008076**

PLATED ELBOW CATCH



Spring loaded securing catch.
Zinc plated steel **008087**

CUPBOARD CATCH BACK SECTION



Replacement back catch and striker set. Comes complete with two striker plates and screws. **008077**

BAGGAGE DOOR CATCH



Keeps baggage compartment open. Catch mounts on vehicle and allows easy, trouble free access. White plastic. **008067**

ROLLER CATCH



A positive action roller catch. **008059**

GRIPPER CATCHES



Vertical Striker



Horizontal Striker

2 piece, strong and positive nylon gripper catch for cupboard doors and drawers.

Vertical striker **008061**
Horizontal striker **008062**
Female section **008063**

PUSH LOCK



White. Suitable for shower door. **008120**

CHROME PLATED PULL TYPE HANDLE - EMRO



100mm **007977**
150mm **007979**

VECAM PLASTIC GRAB HANDLE

Grey	007980
Grey Gasket	007981
White	007983
White Gasket	007984

FLUSH PULL RINGS

Hinged pull ring set in polished brass flush fitting plate.

40mm x 50mm	008177
50mm x 64mm	008178

PIANO HINGE

Continuous lightweight hinge.
2m lengths

008040

MINI DOOR HINGE

Semi concealed lightweight, non-rusting,
aluminium hinge for mini access doors.

015651

PANORAMA CARAVAN DOOR HINGE

PVC 3 piece set

013579

TRIMATIC CARAVAN DOOR HINGE

PVC 4 piece set

014407

**CUPBOARD HINGES
SEMI CONCEALED**

Popular small flat leaf hinge

Florentine bronze	008024
Brass	008025



Flat



Offset

Larger concealed flat flange for fixing to wide
cupboard door trim frames. The offset hinge
designed for use with DE5 cupboard door
moulding

Flat

Florentine bronze	008026
Brass	008027

Offset

Florentine bronze	008028
-------------------	--------



Flat



Offset

Flat

Chrome nickel	008031
---------------	--------

Offset

Chrome nickel	008033
---------------	--------

BUTTERFLY HINGES

Decorative exposed hinge

Nickel plated	008034
Brass plated	008036
Florentine bronze	008037

BUTT HINGES

Nylon, durable, heavy duty.

51mm	008019
76mm	008020

ROSETTES AND KNOBS

Back Catch



Rosette and Knob

KNOBS**Mini**

Brass	008136
Nickel plated	008137

16-19mm

Brass	008130
Brown	008131
Nickel plated	008133
White	008134

ROSETTES

Size refers to the cupboard wood thickness,
not the size of the rosette.

Mini

Polished brass	008140
Nickel plated	008141

16mm

Brass	008147
Nickel plated	008150

19mm

Brass	008153
Brown	008154
Nickle plated	008156

BACK CATCHES**Mini**

Brown	008143
Nickel plated	008144
White	008145

Push Button

Matt nickel	008096
White	008097

Angle striker plate	008103
Brown Push lock with rod access	008119

CAMEC 3 POINT DOOR LOCK

Complete Lock Assembly - Black

Left Hand Hinged **039323**
 Right Hand Hinged **039324**

Remote Latch Assembly

Left Hand **014386**
 Right Hand **014387**

Outer Door Trim
014388

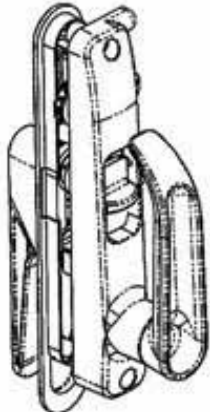

Main Door Lock

Left Hand **014384**
 Right Hand **014385**
 Inner Handle Kit **014381**
 Outer Handle Kit **014382**



Catch Pin
014389



Striker
014383



Hook Catch
014390

Barrel and Key
014392



PANORAMA MK11 DOOR LOCK



013581

PANORAMA DOOR LOCK



Complete **013552**
 Complete (keyed alike) **013553**
 Outer lock **013554**
 Inner lock **013555**
 Striker plate **013556**

TRIMATIC DOOR LOCK



Complete **014396**
 Outer lock **014395**
 Inner lock **014398**
 Striker plate **014399**
 Outer door plate **014401**

LOCKWOOD STREAMLATCH 200



Chromed main door lock ideal for narrow door stiles. **008235**

BOOT STORAGE DOOR LOCK KIT



Replacement "T" handle with threaded shaft for boot doors **015642**

COIN MACHINE LOCK



Threaded cylinder lock commonly used on access doors. Available with either random or alike keying

Short Thread

Keyed randomly **035550**

Keyed alike **008240**

Long thread

Keyed alike **008242**

Keyed randomly **008243**

CAMLOCK - WING NUT TYPE



Chrome plated thumb operated camlock for baggage doors. Not lockable. **008252**

TULIP SCREEN DOOR LOCK



Used on camper trailer doors and shower doors. Silver. **008244**

CAMLOCK ACCESS DOOR LOCK



The long tongue on this lock makes it ideally suited for access doors. It has been used on some early Viscount and some Jayco camper doors. **008231**

"T" SHAPE HANDLE



Locking **008246**
 Latch Tongue to suit **008248**

PROTEX CLAMPS



Straight Clip
 Standard **008278**
 Lockable **008280**



Offset Cl
 Standard **008279**
 Lockable **008281**

CAMPER STYLE TOGGLE CLAMP



Silver
 Standard **008265**
 Lockable **008267**
 J Clip **008270**
 Standard Tongue **008269**
 Locking tongue **008271**

HATCH FASTENER

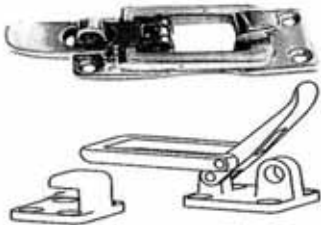

Standard flat mounting. Long shank, lever action with an eye for a padlock.
 45mm x 30mm. **008275**

DROP NOSE PIN



This simple locking device has many applications such as securing the raiser arm roof clamp. **008289**

BONNET CATCH SET CHROME



Straight. **008337**
 Offset. **008338**

UTILITY FASTENERS

GALVANISED



Straight. Sold in pairs **035357**



Bent. Sold in pairs. **035315**



All Pupos. **035317**

BLACK



Alko. Sold in pairs **035344**

ANTI LUCE



Bolt On. **035320**

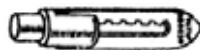

Weld On. **035322**

GAS STRUTS

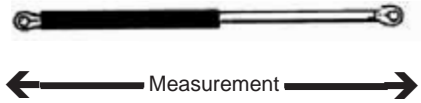

Capacity With Ball	Length	
330N	825mm	008395
435N	825mm	008396
240N	825mm	008397
290N	825mm	008398
100N	525mm	008406
150N	525mm	008407
200N	525mm	008408
250N	525mm	008409
300N	525mm	008410
350N	525mm	008411
400N	525mm	008412
500N	525mm	008413
600N	525mm	008414
150N	320mm	015645
600N	535mm	035297
250N	430mm	035302
150N	450mm	035305
230N	Coromal	008424
330N	Coromal	008425
400N	Coromal	008426

With Cup and Ball

300N 705mm **008391**

No Cup or Ball

300N 818mm Jayco **008393**

400N 818mm **008394**

UTILITY LYNCH PIN TRACTOR CLIP



035385

CUPBOARD STAY - SPRING LOADED



Spring loaded. Opens to 160mm overall. Suitable for supporting top hinged cupboard doors. **008008**

FIRMOTOP CUPBOARD STAY



Chromed finish cupboard stay up. Spring pressure supports the flap when raised and holds it firmly against the cabinet when closed. Opens to 130mm overall. **008009**

FOLDING BRACKET



305mm spring loaded. White. **008006**

PLASTIC STAY UP TYPE STAY



Positive plastic overhead cupboard door support stay. Beige. **008007**

FOLDING WINDOW STAY 802



Used as a window, wardrobe or hatch stay in caravans.

Large **008013**
Small **008014**

WINDOW STAY

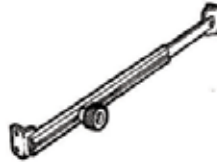

250mm **016419**
200mm **016420**
100mm **016421**

ANTI RATTLE CATCH (SWING BOLT) WITH PLATE



38mm **007997**
50mm **007998**

VISCOUNT SPRING LOADED ANTI RATTLE CATCH

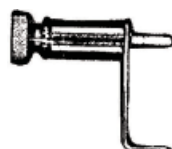

008002

MILLARD SPRING LOADED ANTI RATTLE CATCH



008001

KNURLED NUT



1/4" suit Anti Rattle Catch **008003**
1/16" Medium 20mm wide **016422**
3/16" suit Shade Stay **016423**

STARLITE SECURITY CATCH



Locks shade for travel. 2 piece. **016417**

BREHA CANOPY LIFT MECHANISMS



Canopy lift mechanisms are used to raise and lower the roof of pop top cravans and campervans.

Spring Tension	Max. wgt per pce	Max. lift mm	Width mm	
Std	35kg	560	700	008341
Std	40kg	685	900	008342
Soft	30kg	685	900	008344
Std	35kg	990	1200	008345

BREHA CANOPY LIFT MECHANISM NYLON ROLLER & RIVET



Roller **008347**
Rivet **008348**

CANOPY LIFT MECHANISM SPARE SPRINGS

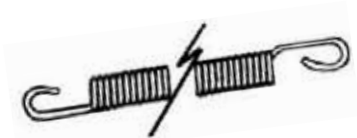

Breha
Suits 700mm lifter **008350**
Suits 900mm lifter **008351**
Suits 1200mm lifter **008352**
Tubular
Suits 900mm **008359**

TUBULAR CANOPY LIFT MECHANISMS



Spring tension: Standard
Max. weight: 40kg per piece
Max. lift: 685mm
Width: 900mm **008353**

TUBULAR CANOPY LIFT MECHANISM NYLON ROLLER & RIVET



Roller **008355**
Rivet **008356**

POP TOP ROOF SUPPORT - INTERIOR



Internal support for pop top camper roof. **035303**

CAMPER TRAILER LIFTERS



3-Stage lifter **008302**

CAMPER FLEXIBLE PUSH ROD & PLUG



Flexible push rod **008305**

CAMPER TRAILER WINCH HANDLE



008328

SLUGS TO SUIT WIND UP MECHANISM KIT



Set of 4 **008307**

PULLEY WHEEL



008320

STAINLESS STEEL CABLE 3/32"



Suits wind-up mechanisms. **008332**

CAMPER TRAILER BED RAILS



1275mm (l) 45mm (w) **008290**

COLD GALVANISING PAINT



375g aerosol **035435**

CARAVAN TOUCH UP PAINT



150g aerosol cans
Violettone White **007105**
Yellowtone White **007106**
Cream **007107**

CLOTH TAPE



48mm (w)
4.5m roll assorted colours **035486**

NON SKID GRIT TAPE

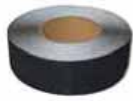

Anti slip grit surface improves footing on steps, ladders and trailer frames. 18m roll.

50mm wide **000167**

PYRAMID (STONEGUARD) MATTING

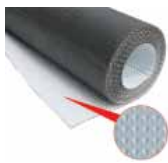

Rubber pyramid matting used as protection for the lower front of caravans, etc. to prevent damage from stones. 914mm (w) 2.4m (l).

Black **000472**

Grey **000476**

COMBI CURTAIN TRACK



Clear anodised drilled without runners 5m length. **007779**

COMBI CURTAIN SLIDE



Plastic slide to suit combi curtain track. **007794**

CAFE CURTAIN CLIP PLASTIC



White **007804**

Beige **007806**

ROLL OUT PANTRY

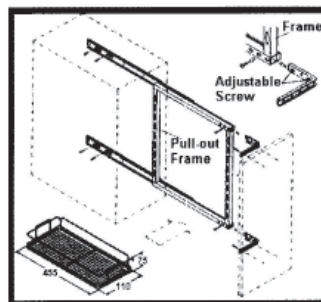

2 Baskets

110mm **000122**

200mm **000125**

Spare basket for 000122 **000124**

Spare basket for 000125 **000127**

3 Baskets

110mm **000123**

260mm **000126**

DECROGLIDE CURTAIN TRACK



5m length White **036495**

DECROGLIDE CURTAIN RUNNER



Plastic **035440**

CURTAIN & GATHER HOOKS



Plastic **007800**

Steel **007799**

JAYCO CURTAIN TABS



007807

CURTAIN RUNNERS



Flat base **007797**

End stop for mini track **007798**

PVC COATED CURTAIN ROD



White steel conduit 16mm dia. 5m length. **007771**

MUSLIN BRACKET



Snap in **007786**

CURTAIN WIRE HOOK & EYE

Eye **007802**
Hook **007803**

PLASTIC COATED CURTAIN WIRE EXPANDING

Per metre **007775**

DOOR STOPS

Square White
45mm **008225**

69mm **008226**



Round White
75mm **008228**

TRAY RAIL

Retaining rail for narrow shelves. For use with pillar ends and throughs. 4mm

Plastic coated 2m length **008206**

Nickel plated 1.8m length **008215**

Polished brass 610mm length **008216**

TRAY RAIL PILLARS 4mm

End pillar Nickel plated **008223**

Through pillar Nickel plated **008219**

Polished brass **008220**

Corner pillar Polished brass **008221**

Nickel plated **008222**

FLYSCREEN PLASTIC SPLINE

Sold per metre

3mm diameter **018030**

4mm diameter **008260**

6mm diameter **015665**

FLYSCREEN TURNBUTTON

Locking device for hinged flyscreens. 5/16" Black. **008258**

FLYSCREEN SPLINE ROLLER

008262

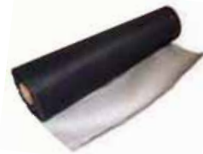
FLYSCREEN FIBREGLASS MESH

Black screen mesh. Sold by the metre.

610mm **021533**

910mm **015662**

SQUEEZE TYPE TABLE LEG

Pivots horizontally under table top.

300mm **007903**

710mm **007904**

7 PIECE TABLE HINGE SET

Attaches table to a bulkhead. Pivoting hinge allows conversion to bed. **007952**

TABLE HINGE - JAYCO

Four way table hinge. Allows the existing table to be extended or folded away.

100mm x 140mm. **007953**

TABLE HINGE SET

Aluminium. Male section mounts on table with the female section attaching to the wall.

2 piece 490mm **035210**

Male section 995mm long **007958**

Female section 995mm long **007959**

TABLE LEG - BI-FOLD 675mm

Unique European style aluminium leg. Adjusts to both table and bed height. The table top can be lifted from the wall bracket and positioned elsewhere on the caravan, even outdoors. Can also serve as a bed base. Bi-fold height 315mm Height: 675mm.

007905

TABLE LEG FOLDING

This unique table top hinge set offers versatility and portability. The table top can be lifted from the wall bracket and conveniently positioned elsewhere on the caravan or outdoors. Height: 675mm **007906**

TABLE LEG TUBE DINETTE

Support legs with hinge for table top

305mm **007873**

355mm **007874**

457mm **007875**

Spare clip/hinge to suit **007908**

TABLE SLIDE KIT



Suits bi-fold and folding table legs. Set of 2 brackets, 950mm alloy track and 2 end plugs. **007960**

BREHA SWINGAWAY BRACKET



Suits most table leg poles that measure approx. 45mm outside diameter.

Short **038519**
Long **038520**

FIAMMA TUBE PRO 70 TABLE LEG



Allows tables to be easily dismantled and stored. Tripod can be used to convert table for outdoor use. The Tube Pro 70 has an aluminium anodized finish and is supplied with 2 plastic caps. The tube can be cut to reduce the height of the table.

Tube - 700mm (a) **040271**
Flush top (b) **007914**
Recessed base (c) **007913**
Folding tripod base (d) **040199**

ACAR ALUMINIUM TABLE LEG FITTINGS



Flush top **035547**
Recessed base **035548**

TABLE LEG CLIPS



For storage of island table leg poles when table is not in use. **007912**

WINEGLASS TABLE LEGS



Plate top suitable for smaller spaces. Beige Height: 685mm, base/plate: 410mm **038034**



Angle iron split top. Height: 730mm, Base: 420mm **007884**



Bent tube. Height: 700mm, base: 430mm **035213**

TUBULAR ISLAND TABLE LEG



Tapered recessed base provides a firm fit and steady support for chrome tube. Height: 655mm, Base/Plate: 200mm **007876**

SWINGER 4 PIECE TABLE LEG



38mm chrome tube. Height: 740mm, Offset: 220mm **007892**

PEDESTAL TABLE LEGS



Freestanding, sturdy table legs with an angle iron top plate for extra support. Can be anchored to the floor for travel but can also be moved for use elsewhere. Height 690mm

Long Base: 615mm x 830mm **007880**



With plate top. Ideal for smaller table tops. Height: 640mm, Base: 610mm **007881**
Chrome tube 46mm dia. 690mm (h) **007924**

TOP CROSSES



To suit Breha pedestal table legs - long leg 660mm x 390mm **007922**

TELESCOPIC GAS STRUT TYPE TABLE LEG



Easy lift with adjustable height floor plate. This allows for correct height setting when table is used as a bed. Overall height: 855mm Closed height: 480mm **007890**